

# LASER GO-FAST TIP #1:

Read This Rigging Guide First.

Laser

Radial

Laser 4.7



Congratulations on the purchase of your new Laser! The Laser is a very unique boat that can accommodate many different sized sailors and abilities, due to its three interchangeable rigs. The Laser, the Radial and the Laser 4.7 all use the same hull and equipment with the exception of the lower mast and sail.

We suggest that you read through this guide to better familiarize yourself with the parts and rigging of your new boat. If you have any questions please contact your dealer or call Vanguard's customer service at 1-800-966-SAIL.

Depending of which Laser you have selected (Laser, Radial or Laser 4.7) you will have one of the following sails and corresponding lower masts located in your delivery kit.



Above from left to right: Laser lower mast, Radial lower mast, and Laser 4.7 lower mast.



Above from left to right: Laser sail, Radial sail, Laser 4.7 sail



Your boat rigged will resemble one of the Lasers shown above. From left to right: Laser, Radial, and Laser 4.7.

Locate your delivery kit. Depending on which model you have purchased (Pro or Standard) there will be a few differences in some of the hardware. The differences between the two models are the cunningham, outhaul, vang and tiller extension. Using images 1 or 2, identify the contents of your kit. To avoid damaging the contents, be sure not to cut into the packaging inside the box.

### Unpacking and Preparation: Laser, Radial & Laser 4.7 Standard Delivery Kit



Image 1

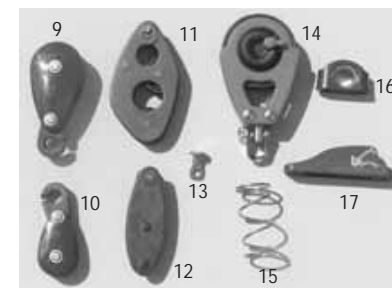

Image 2

Image 1

- |                              |                             |
|------------------------------|-----------------------------|
| 1. Sail Numbers              | 10. Small traveler block    |
| 2. Line Bag                  | 11. Large vang block        |
| 3. Tiller with 33" extension | 12. Small vang block        |
| 4. Rudder                    | 13. Vang Key                |
| 5. Daggerboard               | 14. Mainsheet ratchet block |
| 6. Battens                   | 15. Spring                  |
| 7. Boom                      | 16. Bullseye fairlead       |
| 8. Upper mast                | 17. Clam cleat              |
| 9. Large traveler block      |                             |

### Unpacking and Preparation: Laser, Radial & Laser 4.7 Pro Delivery Kit



Image 2

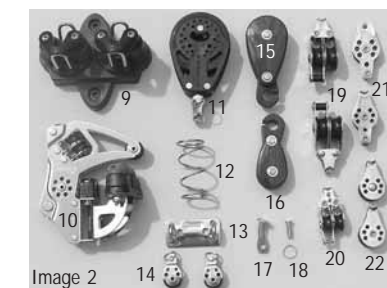

Image 2

Image 2

- |                                     |  |
|-------------------------------------|--|
| 1. Sail Numbers                     | 12. Spring                             |
| 2. Line Bag                         | 13. Forkhead block base                |
| 3. Tiller with 48" extension        | 14. 16 mm Forkhead blocks (2)          |
| 4. Rudder                           | 15. Large traveler block               |
| 5. Daggerboard                      | 16. Small traveler block               |
| 6. Battens                          | 17. Vang key                           |
| 7. Boom                             | 18. Pin and ring                       |
| 8. Upper mast                       | 19. Double micro block with becket (2) |
| 9. Cleat base with cleats           | 20. Small double block with becket     |
| 10. Lower vang block/cleat assembly | 21. Micro block with becket (2)        |
| 11. Mainsheet ratchet block         | 22. Micro single block (2)             |

Useful Knots to Know:

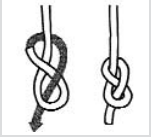
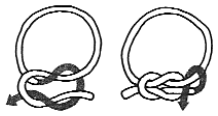

Figure 8 Knot or Stopper Knot



Square Knot



Bowline

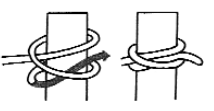

Clove Hitch



Cleat

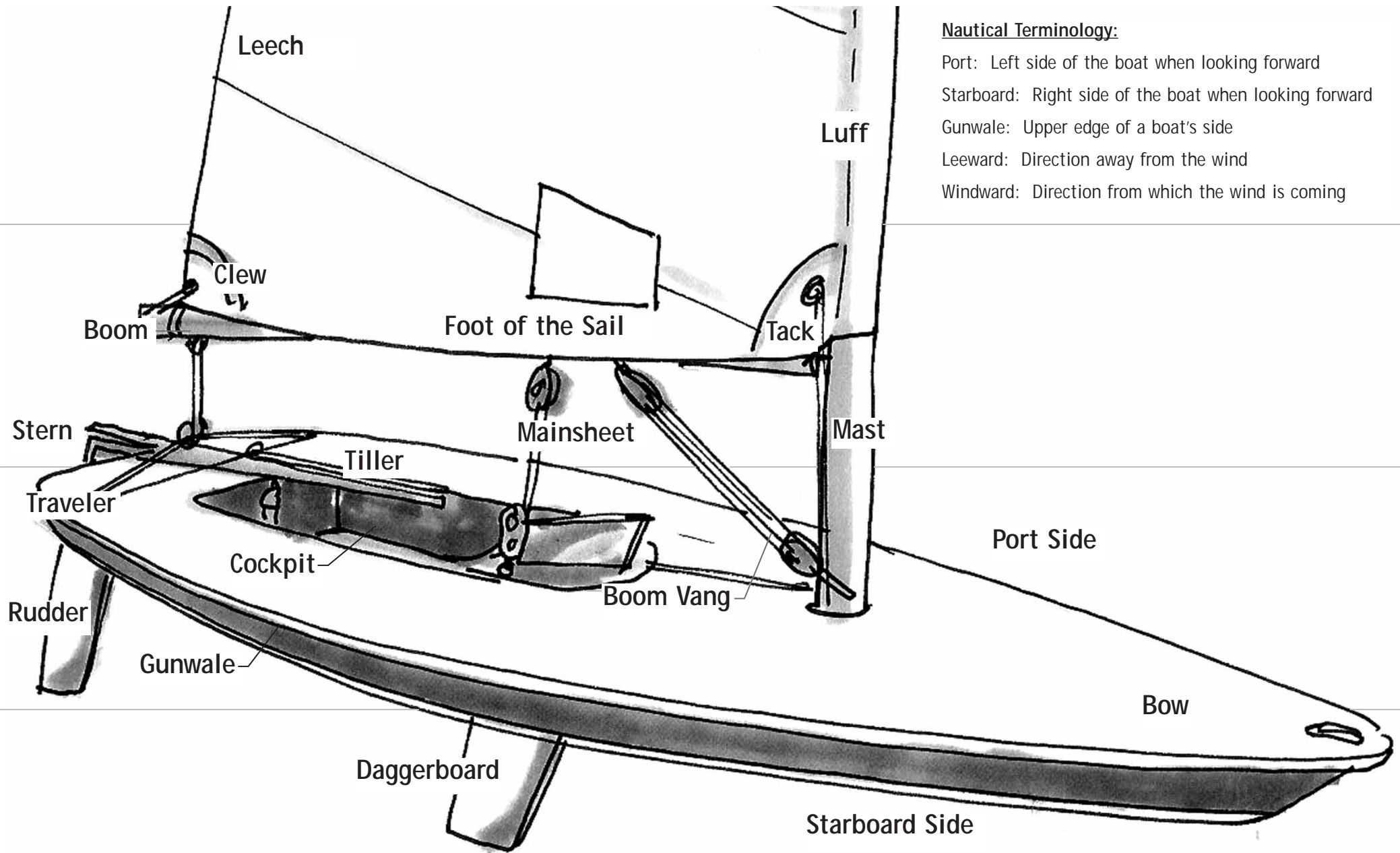

Nautical Terminology:

- Port: Left side of the boat when looking forward
- Starboard: Right side of the boat when looking forward
- Gunwale: Upper edge of a boat's side
- Leeward: Direction away from the wind
- Windward: Direction from which the wind is coming



Here is a list of tools that we recommend you have in order to assemble your new Laser:

Utility Knife



White Electrical Tape



Phillips Head Screwdriver



Silicone Sealant



## Hardware Location:

There are a few pieces of hardware that you will need to install on your new hull before continuing to rig your Laser. Locate the two sets of screws that are positioned on the deck of the boat (Figure A, far right image). One set of screws will be forward of the daggerboard well (Figure 1) while the other set will be aft of the mast step (Figure 2).

**Tip:** Before replacing the screws be sure to dip them into a silicon based sealant to allow for a water tight and secure fit.



Figure 1

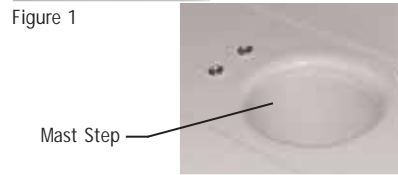
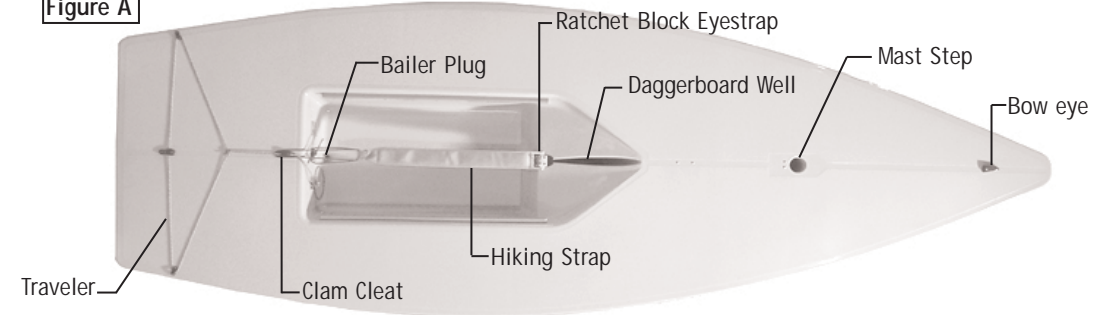

Figure 2

## Figure A



## Hardware Installation: Laser Standard Models

1. In the delivery kit locate the bullseye fairlead and the clam cleat. Unscrew the two screws located by the mast step (Figure 3). Align the bullseye fairlead over the two holes and screw into place (Figure 4).

**Reminder:** Before replacing the screws be sure to dip them into a silicon based sealant to allow for a water tight and secure fit.



Figure 3



Figure 4

2. Unscrew the set of screws located in front of the daggerboard well. Align the holes of the clam cleat and screw into place (Figure 5). Be sure that the open end of the cleat is facing towards the cockpit (Figure 6).

**Reminder:** Before replacing the screws be sure to dip them into a silicon based sealant to allow for a water tight and secure fit.



Figure 5



Figure 6

3. Locate the ratchet block and spring from the delivery kit. In the cockpit, at the forward end of the hiking strap, locate the eyestay (Figure 7).

4. Remove the shackle from the bottom of the ratchet block and place it around the eyestay (Figure 7).

5. Place the spring over the eyestay, and compress. While the spring is compressed, attach the block to the shackle with the pin and ring (Figure 8).



Figure 7



Figure 8

## Hardware Installation: Laser Pro Models

1. From the delivery kit locate the 2, 16mm forkhead blocks and base. Unscrew the two screws located by the mast step. Align the block base over the holes and screw into place (Figure 9). Attach the forkhead blocks to the base using the provided pins and rings (Figure 10).

**Reminder:** Before replacing the screws be sure to dip them into a silicon based sealant to allow for a water tight and secure fit.

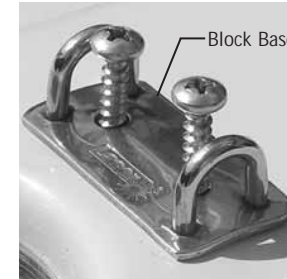

Figure 9

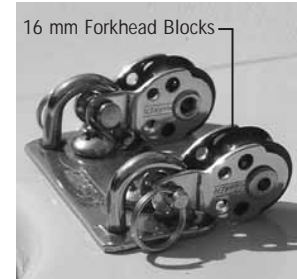

Figure 10

2. In the delivery kit locate the cleat base with cleats. Unscrew the two screws located by the daggerboard well. Align the cleat base over the two holes and screw into place (Figure 11). Make sure that the shorter of the metal fairleads are facing the bow. When looking at the cleat base from the side, the cleats should be angled down towards the bow (Figure 12).

**Reminder:** Before replacing the screws be sure to dip them into a silicon based sealant to allow for a water tight and secure fit.



Figure 11



Figure 12

3. Locate the ratchet block and spring from the delivery kit. In the cockpit, at the forward end of the hiking strap, locate the eyestay (Figure 13).

4. Remove the shackle from the bottom of the ratchet block and place it around the eyestay (Figure 13).

5. Place the spring over the eyestay, and compress. While the spring is compressed, attach the block to the shackle with the pin and ring (Figure 14).



Figure 13



Figure 14

## Rigging the Traveler: Laser Standard Models

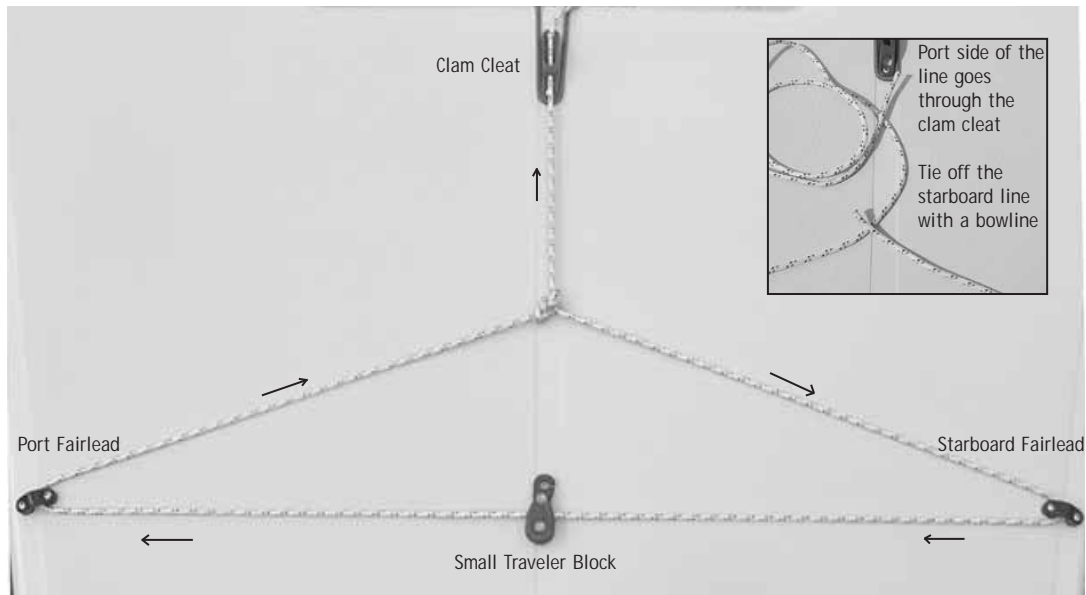

Figure B: Rigged Laser Standard Traveler

## Rigging the Traveler: Laser Pro Models

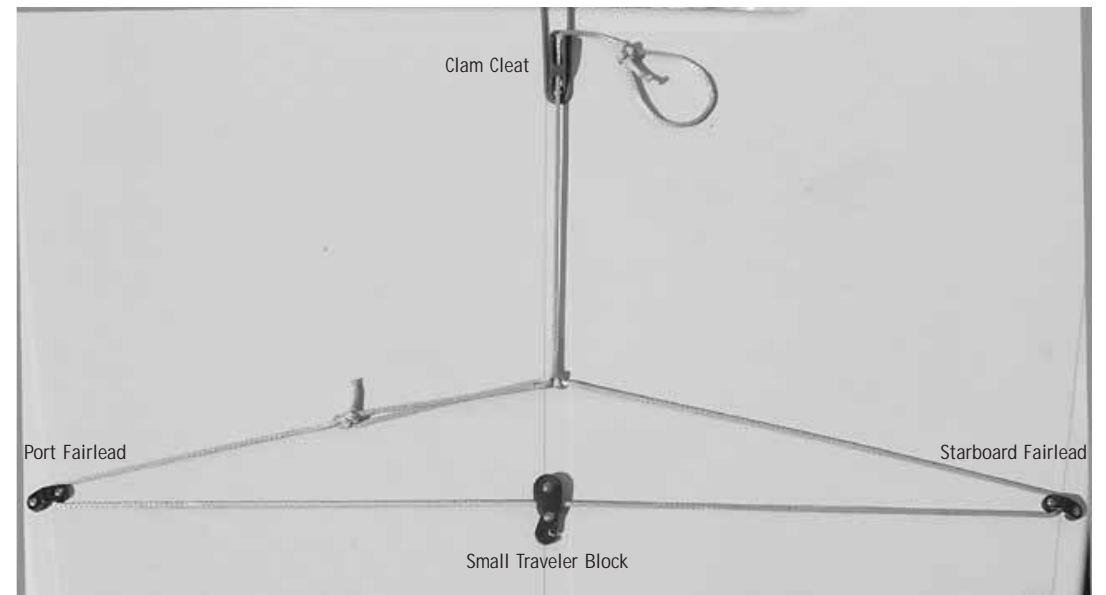

Figure C: Rigged Laser Pro Traveler Line

1. Locate the traveler line and small traveler block from the delivery kit. On the stern of the boat locate the two fairleads (Figure B).

2. Run one end of traveler line through the starboard fairlead (from bow to stern, Figure 15), then through the small traveler block (Figure 16) and continue through the port side fairlead (from stern to bow, Figure 16).

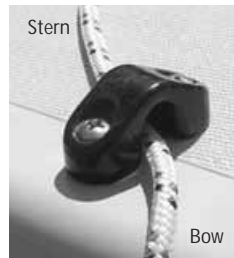

Figure 15



Figure 16

3. Make a loop in the port side of the line as if you were going to tie a bowline (Figure 17). Keeping in mind that the free end of the port side line will be cleated off. Take the starboard end of the line and complete the bowline by going through the port loop (Figure 18).

4. Continue the tail end of the port side line through the cleat and tie off with a bowline handle (Figure 19).

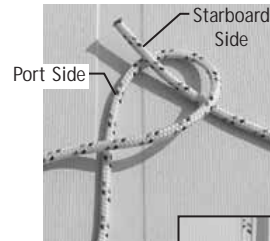

Figure 17



Figure 18

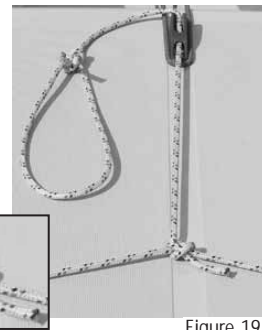

Figure 19

1. Locate the traveler line and small traveler block from the delivery kit. On the stern of the boat locate the two fairleads (Figure C).

2. Run one end of traveler line through the starboard fairlead (from bow to stern), then through the small traveler block and continue through the port side fairlead (from stern to bow, Figure 20).

3. Tie a bowline in the port side of the traveler line (Figure 20). Lead the starboard end of the line through the bowline and pull until snug (Figure 21).

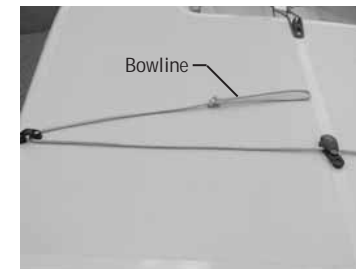

Figure 20



Figure 21

4. With the starboard end of the line tie an overhand knot to secure the line (Figure 22).

5. With the tail end of the line, lead it through the cleat and tie off with a bowline handle (Figure 23).



Figure 22



Figure 23

## Rigging the Mast: Standard and Pro Models

1. Locate the sail, battens, boom, upper and lower mast from your delivery kit. Remove your sail from the sail bag and have the three battens handy. Your battens should comprise of: Two long and one short (Figure 24).



Figure 24

**Tip:** When unfolding sail, make sure that the area is free of sharp objects that could damage the sail! To ensure the batten tips do not fall off inside the pocket when the battens are removed, it is suggested that you tape the batten tips.

2. Unfold the sail. Starting from the head of the sail locate the top batten pocket. Insert the smallest of the three battens into the top batten pocket (Figure 25).

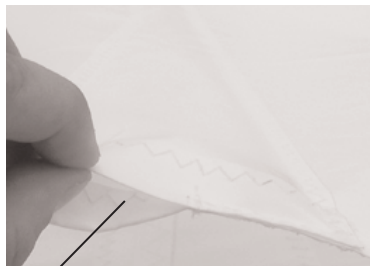

Pocket opening

Figure 25

3. When inserting the batten into the pocket, you will be applying pressure against elastic located in the end of the pocket. As you press against the elastic, slide the batten in and down so that the tip rests in the closed end of the pocket (Figure 26).

To remove: press the end into the elastic, and slide the tip to the open end of the pocket.

4. Continue down the sail, inserting the two remaining battens.

**Note:** Before folding the sail make sure to remove the battens.

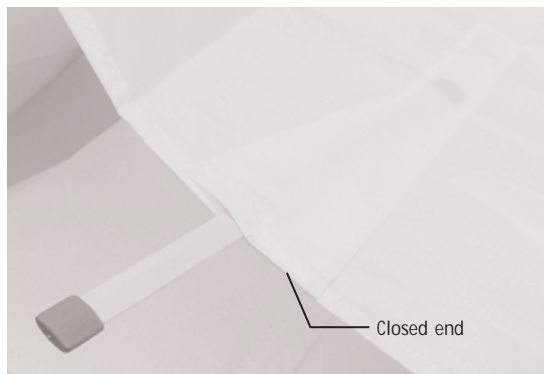

Figure 26

Closed end

5. Slide the top section of the mast into the lower section until the top sections plastic collar is snug against the aluminum of the lower section.

6. Find the opening in the sail sleeve located at the foot of the sail (Figure 27). Slide the sleeve of the sail over the mast, aligning the cunningham grommet with the gooseneck and removing any twists in the sleeve (Figure D).

**Tip:** The head of the sail does not rotate easily on the masthead, so it is suggested to align the head of the sail with the gooseneck before stepping the mast (Figure D).

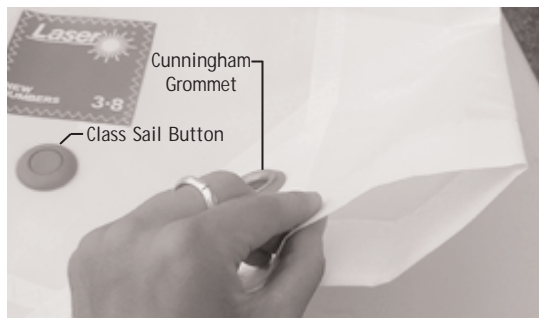

Figure 27



Figure D: Stepping the Mast

## Attaching the Boom:

1. Before attaching the boom locate the outhaul line from the delivery kit line bag. Insert the gooseneck pin into the forward end of the boom and walk aft, exerting pressure towards the mast, to keep it in place (Figure 28).

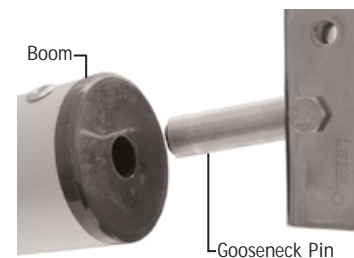

Figure 28

## Stepping the Mast

1. Make sure the bow of the boat is pointing into the wind and that they are **No Overhead Electrical Wires in the Area!** Also make sure that the mast step hole and mast butt are perfectly clean; any sand or dirt in the mast step will grind into the gelcoat and can damage the mast step.

2. Place the mast butt against a flat solid object. By placing a towel or piece of cardboard on the ground it will help prolong the life of the plastic mast butt.

3. Lift the mast from the head of the sail and walk toward the mast butt, raising the mast hand over hand until vertical.

4. Make sure that the gooseneck is facing the stern of the boat before lifting.

5. Keeping your hands a good distance apart, lift the mast over the mast step hole (Figure D).

6. Allow the mast to slide into the step. Do not drop the mast into the step for it will cause damage!

7. Remove any wraps in the sail sleeve.



## Rigging the Outhaul: Laser Standard Models

1. Locate the outhaul line from the delivery kit line bag. Tie a bowline with the outhaul line to the fairlead located at the end of the boom (Figure 29).



Figure 29

2. Lead the line through the grommet in the clew of the sail and then back through the fairlead (Figure 30).

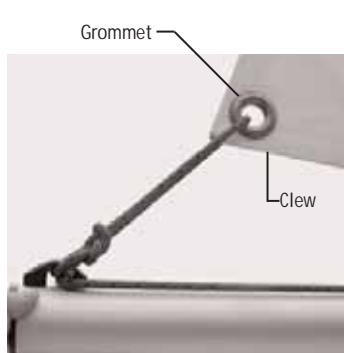

Figure 30

3. Lead the line forward along the boom and cleat off at the clam cleat on the top of the boom (Figure 31). Tie a bowline in the free end of the line (Figure 32).



Figure 31



Figure 32

## Rigging the Clew Tie Down: Laser Standard

1. Locate the clew tie down line from the delivery kit line bag.

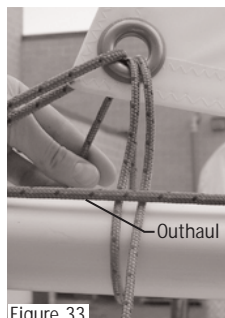

Figure 33

2. Wrap the clew tie down line through the clew grommet and around the boom two times (Figure 33) and secure it with a square knot (Figure 34). Be sure that the line runs on the inside of the outhaul.



Figure 34

Tip: The clew tie down should hold the clew of the sail close to the boom yet it should still be able to slide forward and aft when adjusting the outhaul.



Complete Outhaul

## Rigging the Outhaul: Laser Pro Models

1. Locate the outhaul primary line from the delivery kit line bag. Tie a bowline to the fairlead located at the end of the boom (Figure 35). Lead the free end of the line through the grommet in the clew of the sail and then back to the end of the boom.



Figure 35

2. Retrieve the micro block with becket from the delivery kit. With a bowline, tie the free end of the outhaul primary line to the micro block with becket (Figure 36).



Figure 36

3. Locate the outhaul retainer from the line bag and the two micro single blocks from the delivery kit. Take one end of the outhaul retainer and tie a bowline to one of the micro single blocks. With the free end of the retainer line, wrap the line around the mast, above the gooseneck, and tie a bowline. Be sure to leave enough length in the tail of the line to tie on the second micro single block (Figure 37).



Figure 37

4. From the line bag find the outhaul secondary line. Tie a bowline to the becket on the micro block with becket (Figure 38). Lead the free end of the line towards the mast and counter clockwise through one of the micro single blocks (Figure 39).

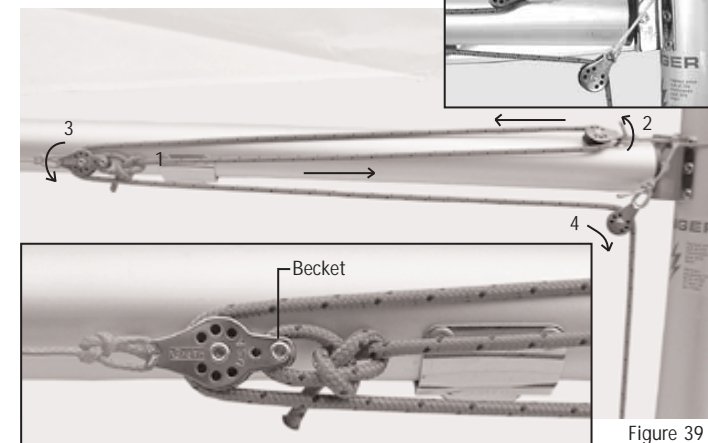

Figure 38

Figure 39

5. Continue the line back through the micro block with becket and forward to the remaining single block on the mast (Figure 39).

6. Lead the outhaul secondary down to the deck, through the forkhead block, through the starboard deck cleat and cleat off. Tie a bowline in the tail to use as a handle.

## Rigging the Clew Tie Down: Laser Pro

1. Locate the clew tie down line from the delivery kit line bag.

2. Wrap the clew tie down line through the clew grommet and around the boom two times and secure it with a square knot (Figure 40). Be sure that the line runs on the inside of the outhaul.



Figure 40

Option: You can purchase (through your local dealer) a clew tie down strap (Figure 41). Release the Velcro so that the strap is straight. Wrap the longer end of the strap (the length without the Laser logo) around the boom and through the d-ring. Continue the strap around the boom and secure the Velcro. Thread the Velcro strap with the Laser logo through the clew grommet and secure.



Figure 41

## Rigging the Vang: Laser Standard Models

1. Locate the vang line from the delivery kit line bag. Retrieve the two vang blocks and vang key from the delivery kit.

2. Take the smaller of the two vang blocks and remove the pin and ring. Insert the vang key and secure with the pin and ring (Figure 42). Hook the key into the vang slot on the underside of the boom (Figure 43).

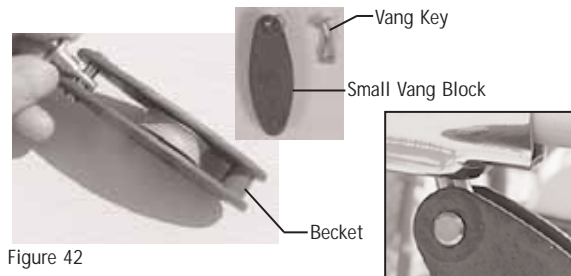

Figure 42

Figure 43

3. Use the provided pin and ring to attach the larger of the two vang blocks to the vang tang, located below the gooseneck on the mast (Figure 44). Make sure that the cleat is on the bottom side of the block.

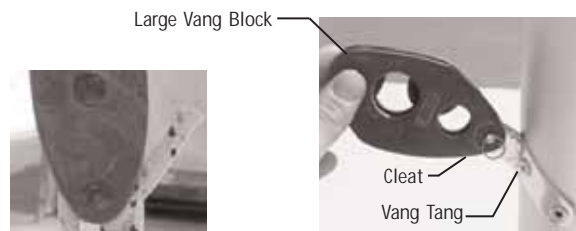

Figure 44

4. Take one end of the vang line and tie a bowline to the becket on the small vang block on the boom (Figure 45).



Figure 45

5. Lead the line to the forward vang block and through the upper sheave of the large vang block on the mast (Figure 46).

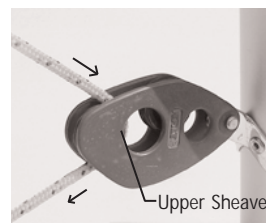

Figure 46

6. Lead the line back up and around the small vang block on the boom and back down to the large mast vang block (Figure 47).

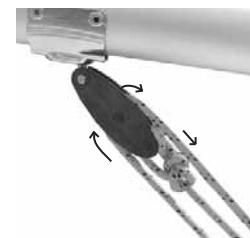

Figure 47

7. Lead the line around the inner block and down through the teeth of the cleat located on the underside of the block (Figure 48). Tie off the free end of the line with a bowline (Figure 49).



Figure 48

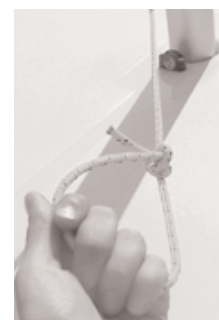

Figure 49



Complete Vang

## Rigging the Vang: Laser Pro Models

From the delivery kit locate: (Figure 50)

1. Lower vang block/cleat assembly
2. Small double block with becket
3. Single block with becket
4. Vang key
5. Vang primary line
6. Vang secondary line

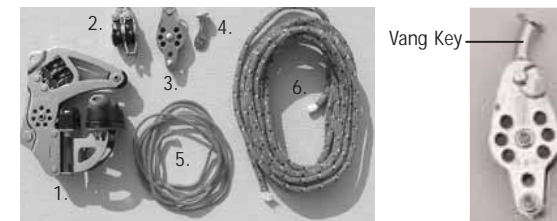

Figure 50

Figure 51

1. Attach the vang key to the micro block with becket with the provided pin and ring (Figure 51).

2. Take the vang secondary line and lead it through the cleat and fairlead of the lower vang block/cleat assembly. Continue the line around the internal block and out by the external sheave. Pull several feet of line through the cleat and fairlead in order to assemble the purchase system (Figure 52).

3. Lead the line clockwise through the small double block with becket. Making sure to go around the block that does not contain the becket (Figure 53).

4. Continue the line down through the lower block on the vang block/cleat assembly and back up and around the small double block with becket.

5. Lead the line through the upper block of the lower vang block/cleat assembly and complete the purchase by tying the tail end of the line to the becket of the small double block with a stopper knot followed by a half hitch (Figure 54).

6. Attach the lower vang block/cleat assembly to the mast tang with the provided pin and ring.

7. Take the primary vang line and tie a bowline to the becket of the single block with key (Figure 55).

8. Lead the line down to the sheave of the vang block/cleat assembly (Figure 56) and then back up through the single block with becket.

9. Tie a bowline to the top of small double block with becket (Figure 57).

10. Attach the vang key to the boom, making sure that the key is curved towards the mast (Figure 58).

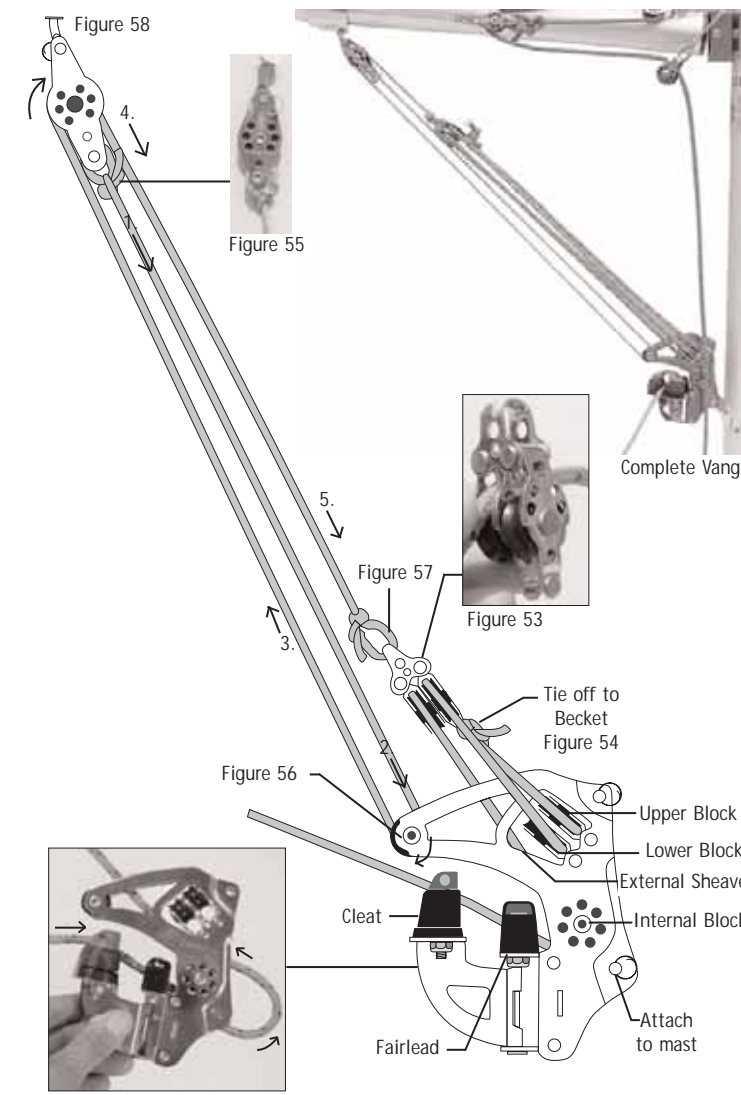

Figure 52



## Fun facts about the Laser.

Did you know....

That the Laser was designed in 1971 by Bruce Kirby.

That in 1996 the Laser debuted at the Olympic Games in Atlanta.

That in 2005 the Laser Radial was chosen as the newest Olympic class for women and will make its debut at the 2008 Olympic games.

That the prototype of what is now commonly known as the Laser was originally named the "Weekender."

### Fact or Fiction:

Bruce Kirby's original sketch of the Laser is known as "the million dollar doodle."

### Visit

[www.teamvanguard.com](http://www.teamvanguard.com) to submit your answer to the Laser "Fact or Fiction" question and register to be entered into a raffle drawing!

## Rigging the Cunningham: Laser Standard Models

1. Locate the cunningham line from the delivery kit.



Figure 59

2. Tie a bowline around the vang tang (Figure 59).

3. Lead the line up through the cunningham grommet in the sail (Figure 60) and back down to the bullseye fairlead on the deck (Figure 61).



Figure 60

4. Lead the line through the clam cleat and tie a bowline in the tail (Figure 62)



Complete Cunningham

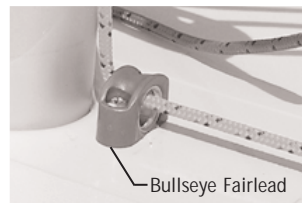

Figure 61



Figure 62

## Rigging the Cunningham: Laser Pro Models

1. Attach the lower cunningham micro block with becket to the top of the lower vang assembly (Figure 63).

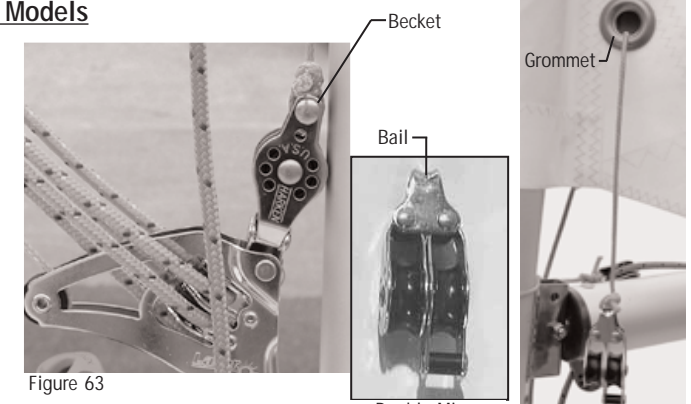

Figure 63

2. Tie a bowline with the cunningham primary line to the becket at the top of the cunningham double micro block with becket (Figure 63).

3. Feed the tail end of the cunningham primary line through the grommet in the sail and tie the free end to the bail of the second micro block with becket (Figure 64).

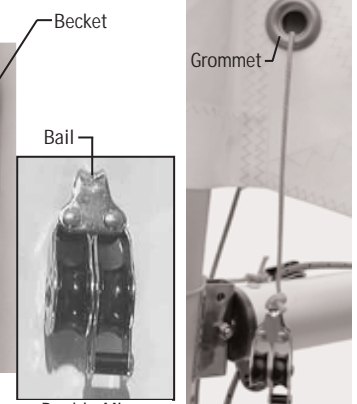

Figure 64

4. Take the cunningham secondary line and tie a bowline to the becket of the upper double micro block with becket (Figure 65).

**Tip:** Make sure both double blocks line up with the becket on the same side.

5. Lead the line counterclockwise through the blocks, starting with the lower of the two double micro blocks with becket. Make sure not to twist or cross the line (Figure 65).

6. Continue the line down through the forkhead block (Figure 66), through the port side deck cleat and cleat off. Tie off the end of the line with a bowline handle.

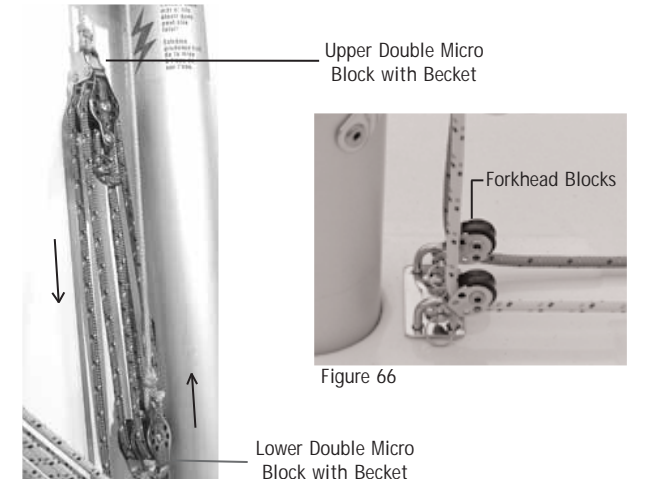

Figure 65

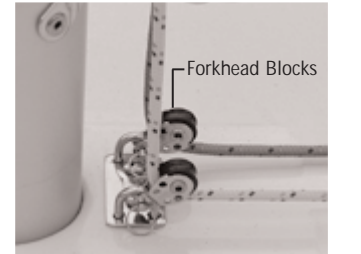

Figure 66

### Mast Retaining Line: Laser Pro Models

The Laser class rules state "To secure the mast in the event of a capsize, a loose retention line (that will allow 180 degrees of rotation) shall be tied between the block base and the vang tang or gooseneck."

Locate the mast retaining line from the delivery kit. Tie a small bowline to the port loop on the block base located by the mast (Figure 67). Lead the line around the mast and over the vang tang. Continue the line around the mast and tie it to the starboard side loop of the block base (Figure 68). Make sure to tie the bowlines at the ends of the line in order to keep the retainer loose. Over tightening of the retainer can cause the plate to bend.



Figure 67

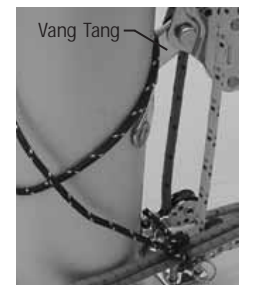

Figure 68

### Daggerboard Retainer, Standard and Pro Models:

1. Retrieve the daggerboard retainer shockcord from the delivery kit line bag. On the ends of the shockcord there will be two brummel hooks (Figure 69).

2. Take one end of the daggerboard retainer and fold it a third of the way down the total length of the line (Figure 69).

3. At the fold in the line, insert the two pieces of shockcord through the hole in the top of the daggerboard (Figure 70 & 71).

4. Take the free ends of the shockcord and put them through the shockcord loop. Pull until tight around the edge of the board (Figure 72).

5. When you are ready to launch, place the daggerboard in the trunk with the shockcord facing towards the bow. Take one end of the daggerboard retaining line around the starboard side of the mast and through the bow handle. Take the other end of the line around the port side and connect the two brummel hooks.

**Tip:** For the Laser Pro model versions it is recommended that you lead both ends of the daggerboard retainer to one side of the mast and hook the brummels around the bow handle. To keep the daggerboard retainer out of the way of the other lines on the deck it is suggested to tie the mast tie in around the daggerboard retainer (Figure 73).



Figure 73

### Rigging the Rudder, Standard and Pro Models:

1. Locate the tiller with extension and rudder from the delivery kit.

2. Take the tiller with extension and slide the tiller into the head of the rudder. Make sure that the rudder downhaul line is threaded up through the pintles (Figure 79).

3. Align the hole in the top of the tiller with that in the rudder head and insert the rudder retaining pin to secure (Figure 80). It is suggested to tape over the retaining pin to prevent the mainsheet from catching on it.

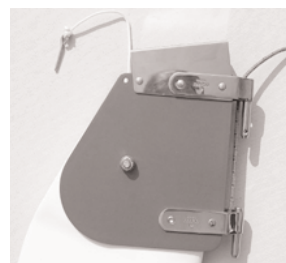

Figure 79



Figure 80

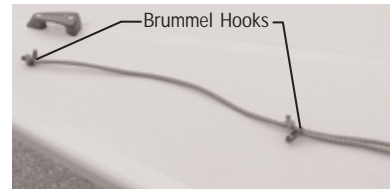

Figure 69



Figure 70



Figure 71



Figure 72

4. Slide the tiller with extension under the traveler line. Align the pintles over the gudgeons and press down to secure (Figure 81). To release press on the rudder lift stop and lift the rudder head straight up.

5. The rudder downhaul line locks the rudder in the down position. Before launching be sure that the line is loose so that the rudder can remain in the upright position. When you are ready to sail, pull on the rudder downhaul and the rudder blade will lower into the water. Tie off the line to the cleat on the tiller while sailing (Figure 82).



Figure 81



Figure 82

### Mainsheet, Standard and Pro Models:

1. Locate the mainsheet and large traveler block from the delivery kit. At the stern of the boat attach the large traveler block to the small traveler block by joining the hooks (Figure 74).

2. Take the mainsheet through the becket of the boom end block and tie a stopper knot (Figure 75). Lead the line down through the large traveler block and back through the boom end block (Figure 76).

**Note:** The use of a stopper knot here is so that maximum mainsheet tension may be achieved.

3. Continue the line forward through the boom bail (Figure 77), through the forward boom block (Figure 78) and down to the ratchet block. Lead the line through the ratchet block making sure you hear a ratcheting noise when trimming in the sail. Tie a stopper knot in the tail end of the line.

**Note:** Mainsheet block will differ in appearance depending on whether you have a Laser Standard Model or Laser Pro Model.



Figure 74



Figure 75



Figure 76



Figure 77



Figure 78



Laser Pro Block



Laser Standard Block

### Attaching the Rudder

When rigging the rudder it is important to place the tiller and extension underneath the traveler line.

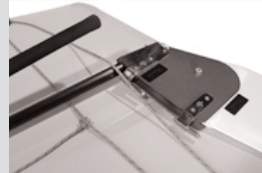

Allow plenty of slack in the traveler line before sliding the entire tiller and extension under only the traveler line that is connected between the two fairleads. Slide the rudder head back and insert the pintles of the rudderhead into place. Tighten the traveler line so that it is taut but still allows the traveler block to move freely across the traveler, clearing the tiller.



### Taping the Traveler Blocks

It is recommended that you tape the traveler block brummels so that they do not become twisted or disconnected.



### Sail Number Application:

Provided in the delivery kit are 4 red and 8 blue or black sail numbers. In order to participate in Laser regattas you will need to apply the numbers to your sail for easy identification.

The sail number corresponds to the identification number that is imprinted on the starboard side of the transom. The identification number will be a series of letters and numbers. The first three letters are the manufacturers code followed by an additional letter that will stand for the first two digits of the sail number. The letter A stands for the number 10, and the progression logically continues with B = 11, C = 12 etc... These first two numbers will be represented on the sail with the red numbers.

The following four digits are the remainder of the sail number. Use the blue or black sail numbers for the remaining 4 digits. For example, if your hull identification number is OQTH4714B506, your sail number would be 174714.

The remainder of the numbers and letters in the identification number will stand for the date in which the boat was manufactured.

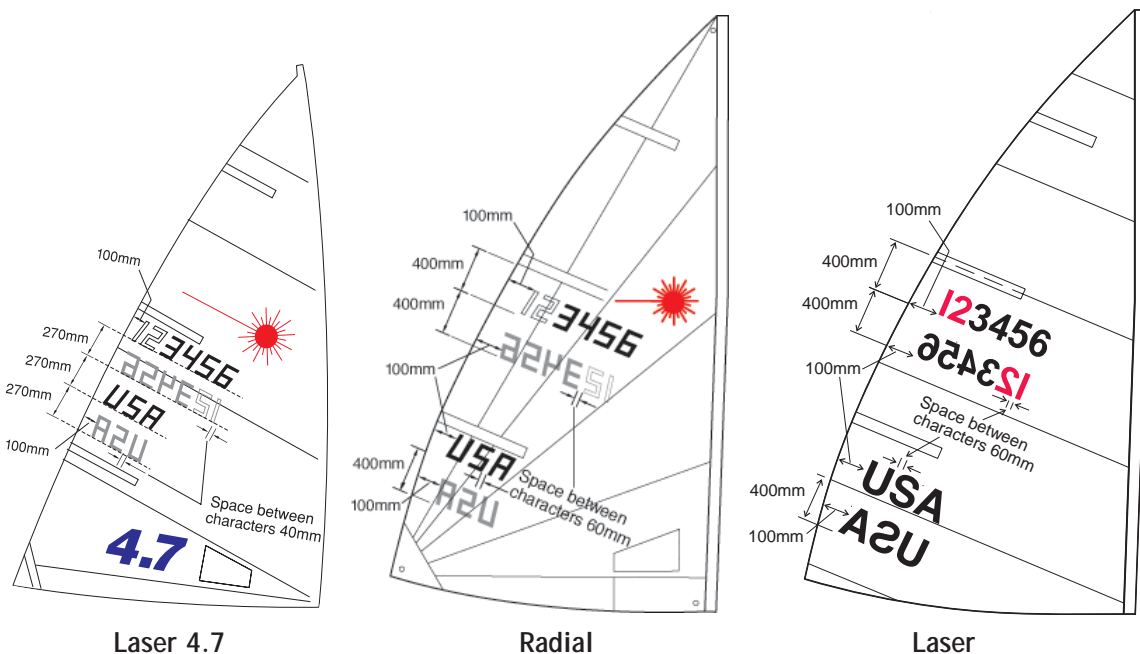

### Sail Care:

It is important to take proper care of your sail in order for it to last longer and perform to the standard that they were designed for. Follow these simple tips to help extend the life of your sail.

1. If you are sailing in salt water, be sure to rinse out your sail with fresh water after every use. Dacron sails do not absorb water or salt but the salt will dry on the sail making them stiff. The salt in humid weather can attract moisture that may lead to mildew on your sail.
2. To wash your sail, NEVER machine wash them. Doing so will damage the material as well as remove the finish of the sail. If your sail becomes dirty, clean it with a mild dish detergent and rinse with fresh water. Do not bleach or use other harsh chemicals on the sail for they can also ruin the finish, decreasing the life of the sail. It is not recommended to store your sail wet, doing so is an invitation for mildew to grow.
3. It is not recommended to dry your sail in the sun because other than when in use, over exposure of UV rays will slowly break down the material of the sail. Be aware of the surface that you are drying your sail on as asphalt and other parking lot surfaces are very abrasive to the sail material and may contain chemicals (i. e. oil) that can damage the sail. Avoid hanging your sails up to dry in the breeze, unnecessary flogging will greatly reduce the life of the sail.
4. Flaking or rolling your sail is highly recommended. Crumpling a sail will crack the finish of the material which quickly reduces the life of the sail (Figure 83).
5. Make sure to regularly inspect your sail for loose or torn stitching or small tears in the cloth. Have any stitching or tears repaired by a local sailmaker before they become more of a problem.

Figure 83

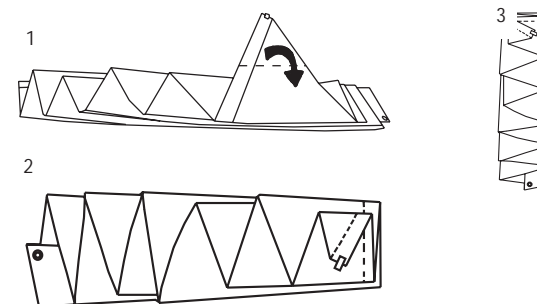

Tip: Remove the battens before flaking the sail.

### Before Launching:

- \* Check that the stern plug and bailer plug are securely in place
- \* Make sure that the automatic bailer is in the closed position (the plug located in the cockpit should be tightly in the hole)

- \* Wear your life jacket

- \* Make sure that you are wearing the appropriate clothing for the conditions that you are sailing in

- \* Be sure to check the weather report before going sailing.

- \* Stay hydrated and bring plenty of water

- \* Wear plenty of sunscreen

- \* Have Fun!



SEITECH dollies are the easy-to-use, light-weight, small boat transportation solution. The Laser dolly has been designed specifically to fit and support the shape of the hull. Special features of the Laser dolly include a rounded bow support for secure transportation and gunwale supports for proper storage. SEITECH dollies allow you to spend less time getting your boat to and from the water and more time on the water.

[www.seitech.com](http://www.seitech.com)



### Laser Class Association

For more information and to link to Laser sailors around the world, join the International Laser Class Association.

[www.laserinternational.org](http://www.laserinternational.org)  
[www.laser.org](http://www.laser.org)







# Owner Information



NOTES:

---



---



---



---



---



---



---



---



---



---

Hull Identification Number: OQT \_\_\_\_\_

Purchased From: \_\_\_\_\_ Date of Purchase: \_\_\_\_\_

Contact Name: \_\_\_\_\_ Phone #: \_\_\_\_\_

Address: \_\_\_\_\_

City: \_\_\_\_\_ State: \_\_\_\_\_ Zip Code: \_\_\_\_\_

Hull Color: \_\_\_\_\_ Sail #: \_\_\_\_\_

**Registration Information (if applicable)**

Trailer VIN #: \_\_\_\_\_

License Plate Number: \_\_\_\_\_ State Register in: \_\_\_\_\_

Registration Number: \_\_\_\_\_ State Register in: \_\_\_\_\_

Insurance Information: \_\_\_\_\_

Maintenance \_\_\_\_\_

\_\_\_\_\_

\_\_\_\_\_



VANGUARD