



A RIGGING GUIDE FOR A BOAT SO EASY TO RIG, IT BARELY NEEDS ONE.



Congratulations on the purchase of your new Sunfish! We suggest that you read through this guide to better familiarize yourself with the parts and rigging of your new boat. If you have any questions please contact your dealer or call Vanguard's customer service at 1-800-966-SAIL.

Parts of the Hull:

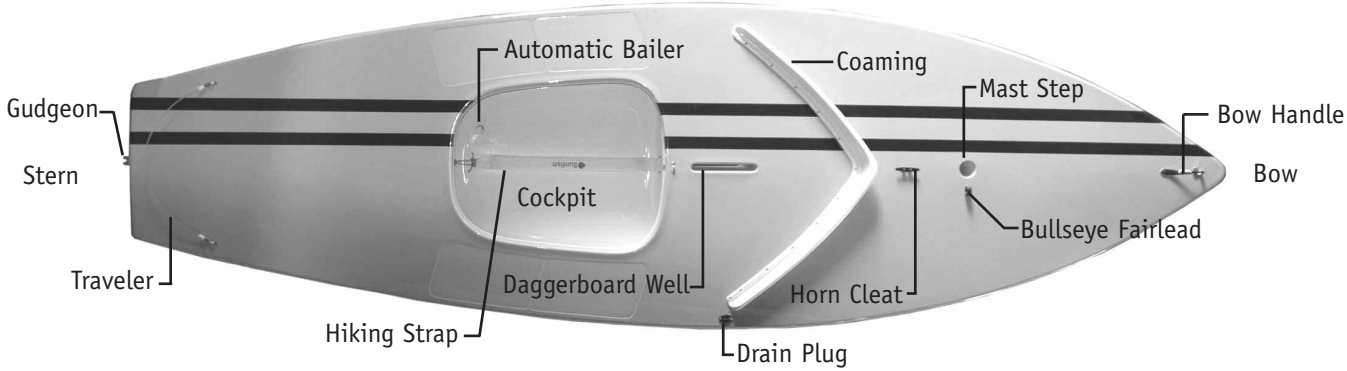

Parts of the Sail:

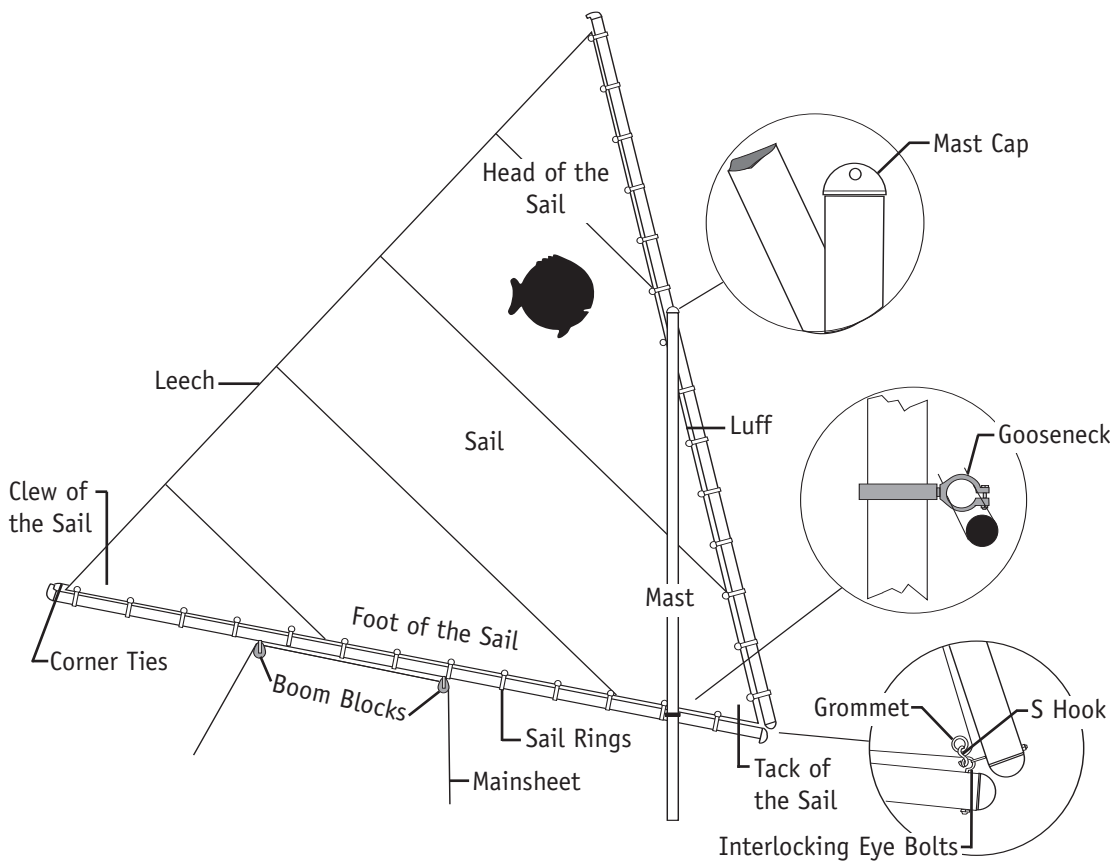

Useful knots to know:

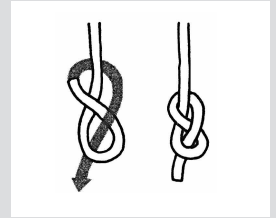
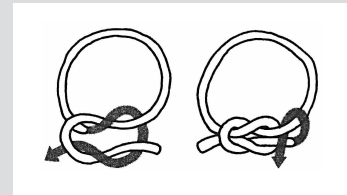

Figure 8 Knot or Stopper Knot



Square Knot



Bowline



Cleat

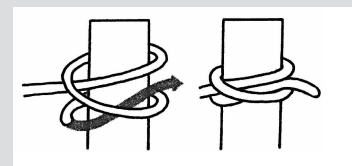

Clove Hitch

Nautical Terminology:

Port: Left side of the boat when looking forward

Starboard: Right side of the boat when looking forward

Gunwale: Upper edge of a boat's side

Leeward: Direction away from the wind

Windward: Direction from which the wind is coming

The Sunfish is available in two models; Standard and Pro. The Pro model comes with equipment most commonly used for racing.

First: Locate your delivery kit. Depending on which model you have purchased (Pro or Standard) there will be a few differences in some of the hardware. Using Figure 1 or 2, identify the contents of your kit. To avoid damaging the contents, be sure not to cut into the packaging inside the box.

Standard Sunfish Delivery Kit:



Figure 1

1. Daggerboard, plastic
2. Tiller with extension (33")
3. Colored sail
4. Rudder, wood
5. Line bag
6. Sail rings
7. Mainsheet ratchet block
8. Bailer parts, Brummel hooks (2), Snap shackle

Pro Sunfish Delivery Kit:



Figure 2

1. Daggerboard, plastic
2. Tiller with extension (36")
3. White race sail
4. Wind indicator
5. Rudder, FRP
6. Line bag
7. Harken mainsheet ratchet block and compression spring
8. Bailer parts, Brummel hooks (2), Snap shackle

Contents of item # 8

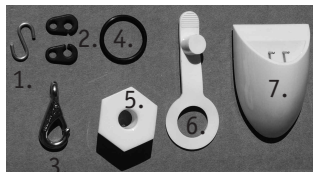

1. S hook
2. Brummel hook (2)
3. Snap shackle
4. Bailer o-ring
5. Bailer cap
6. Bailer plug
7. Bailer housing

Sunfish Mast Kit:

Locate the mast, upper and lower boom. The upper and lower boom will be connected at one end with two interlocking eye bolts (Figure 3). The gooseneck (Figure 4) will come assembled on the lower boom. Depending on the model that you purchased the gooseneck bolt may differ in appearance. On the Sunfish Pro model the gooseneck comes equipped with a quick adjust lever (Figure 5). This lever can easily be released in order to adjust the positioning of the gooseneck on the lower boom. Also located on the Sunfish Pro lower boom are two outhaul clam cleats (Figure 6).

Sunfish Mast Kit Standard:



Figure: 4

Sunfish Mast Kit Pro:

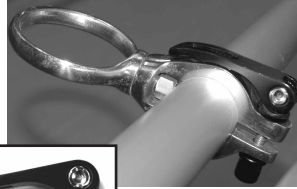

Figure: 5



Standard Mast and Boom Set

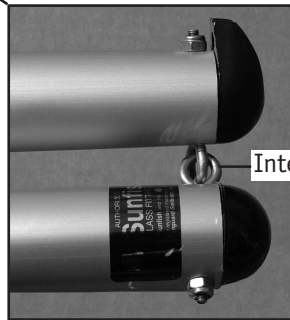
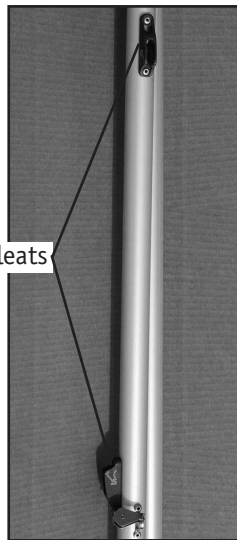

Figure: 3

Interlocking eye bolts



Cleats

Figure: 6

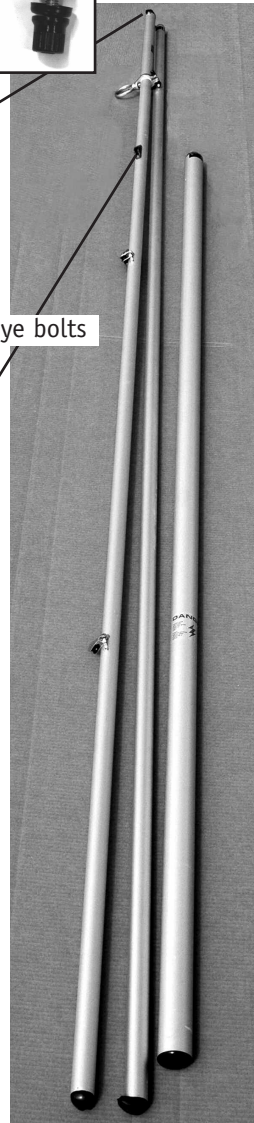

Pro Mast and Boom Set

Here is a list of tools that we recommended you have to assist you in assembling your new Sunfish:

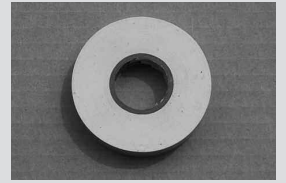

Electrical Tape

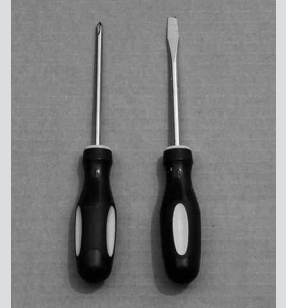

Screw Drivers



Wrenches



Utility Knife



Pliers

Be sure to remove any bubble wrap and plastic coating before rigging.

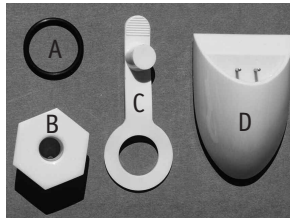
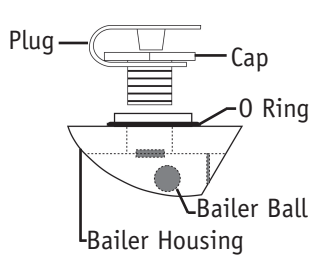

Figure: 7

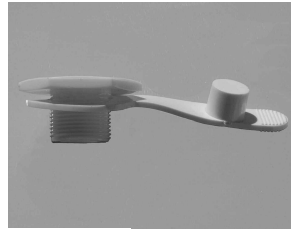

Figure: 8

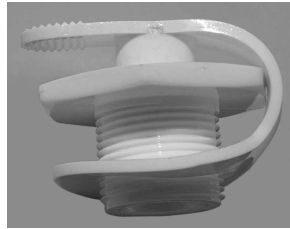

Figure: 9

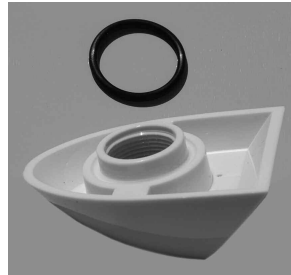

Figure: 10

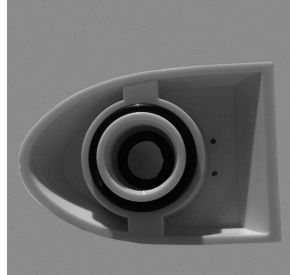

Figure: 11



Figure: 12

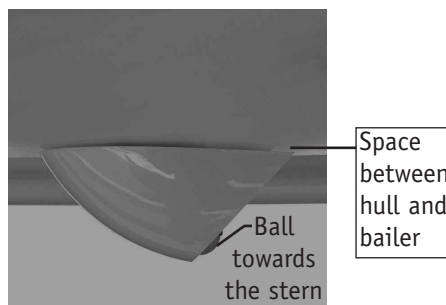

Figure: 13

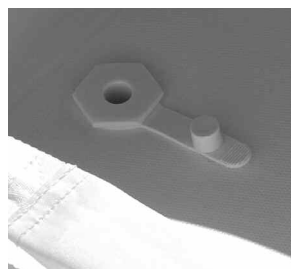

Figure: 14

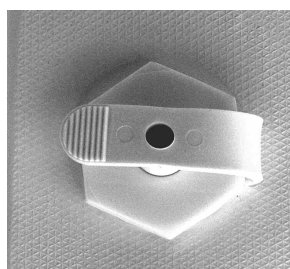

Figure: 15

Bailer Installation:

1. Locate the bailer o-ring (a), cap (b), plug (c) and housing (d) from the delivery kit (Figure 7).

2. Fit the bailer cap into the hole of the plug so that the plug stopper faces upward (Figure 8). Fold the rubber plug over the cap to close (Figure 9).

3. Locate the bailer housing and o-ring (Figure 10). Place the o-ring over the neck of the bailer and push it down completely (Figure 11).

4. Locate the bailer opening in the cockpit (Figure 12). Take the bailer housing with o-ring and place it under the hull, sliding it up through the cockpit. Make sure that the ball in the housing is facing towards the stern of the boat (Figure 13).

5. While holding the housing in place, thread the bailer cap through the cockpit hole and into the bailer housing. Tighten the bailer so that it is hand tight.

Note: The bailer will not sit flush to the bottom of the hull.

6. When open, the stopper of the bailer plug should lie on the cockpit floor pointing towards the bow (Figure 14).

Reminder: The bailer lets water out of the cockpit while you are sailing. Insert the bailer plug in the cap before launching and during sailing (Figure 15). If the cockpit begins to collect water open the bailer to release the water. Note: the boat needs to be moving quickly in order to allow the water to release and not take on more water at the same time.

Meet Eduardo Cordero, 8 time Sunfish World Champion. Spanish born, Eduardo moved to Venezuela in 1982 and is now a resident of the US. With over 15 years of coaching experience; working at world renowned sailing schools, Eduardo is helping to contribute his knowledge back to the sport. Thank you to Eduardo for graciously contributing technical knowledge in helping with this rigging guide. To find out more about Eduardo and his involvement in the sailing community visit: www.starboardpassage.com

Fact or Fiction:

The Sunfish logo was created by Cortland Heyniger by tracing a nickel and adding fins and a tail?

Visit

www.teamvanguard.com to submit your answer to the Sunfish "Fact or Fiction" question and register to be entered into a raffle drawing!

Ratchet Block Installation:

Depending on which model Sunfish you have purchased the ratchet block will be different in appearance. Follow the instructions below for your model Sunfish. Find the mainsheet eyestraps located on the deck forward of the cockpit, aft of the daggerboard well (Figure 16). This is where you will attach the mainsheet ratchet block.

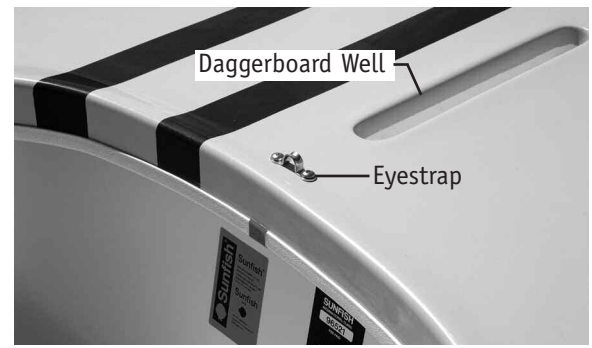

Figure: 16

Ratchet Block Installation Standard:

1. In the delivery kit locate the ratchet block (Figure 17), shackle, pin and ring (Figure 18).

2. Loop the shackle through the eyestraps and align the hole in the shackle with the hole in the bottom of the mainsheet block. Insert the pin and secure with the ring (Figure 19).

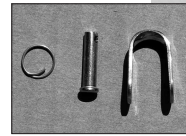

Figure: 18



Figure: 17



Figure: 19

Ratchet Block Installation Pro:

1. In the delivery kit locate the ratchet block (Figure 20), compression spring (Figure 21), shackle, pin and ring (Figure 22).

2. Take the shackle and loop it through the eyestraps. Place the compression spring over the eyestraps (Figure 21).

3. While compressing the spring, place the mainsheet ratchet block at the top of the spring and align the hole in the bottom of the block with the holes in the shackle.

4. Secure the Ratchet block to the shackle using the pin and ring (Figure 23).

Tip: To assist in keeping the spring compressed while attaching the block to the shackle, try compressing the spring and tie with string (Figure 24). Place the tied spring over the eyestraps and attach the block. Then untie the string and release the spring.

Tip: After rigging the mainsheet block some racers prefer to raise the height of the hiking strap in order to more easily get their feet under after a tack. Using a small piece of line or shockcord, thread one end through the forward loop of webbing in the hiking strap. Continue the line through the mainsheet block eyestraps (Figure 21). Be sure to tie the line tightly in order to keep the strap in the lifted position.

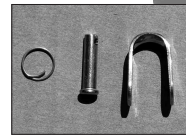

Figure: 22



Figure: 20



Figure: 21



Figure: 23



Figure: 24

Attaching the Sail to the Booms (Standard):

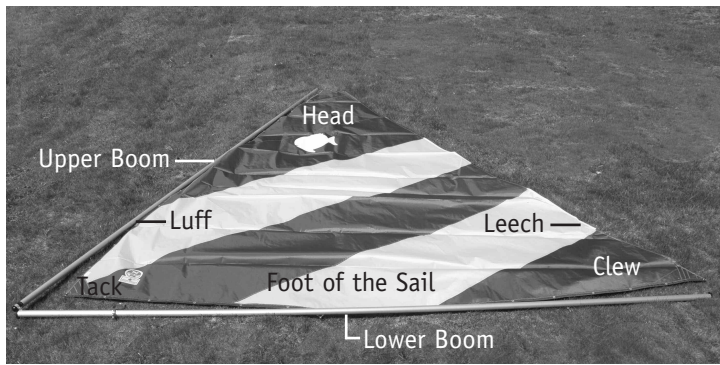

Figure: 25

1. From the delivery kit locate the sail, upper and lower booms, S hook and package of sail rings. Remove the two outhaul lines from the line bag.

2. Find a flat surface free of sharp objects that you can spread your sail out on.

3. Align the lower boom along the foot of the sail and the upper boom along the luff (Figure 25). The Sunfish logo should face the upper boom; the boom that does not have any blocks attached.

4. The two booms are attached together by interlocking eye bolts. This corner of the sail is known as the tack. Take the S hook and loop one end through the interlocking eye bolt that is attached to the lower boom (Figure 26).

5. Take the free end of the S hook and place it through the grommet in the tack of the sail. Using a pair of pliers, crimp the S hook closed (Figure 27).

6. Attaching the outhaul lines: Starting at either the head of the sail or the clew (one of the ends that is not yet attached to the booms) take one of the outhaul lines and tie a stopper knot in the end of it. Feed the free end of the line through the boom cap (Figure 28).

7. Continue the line through the grommet in the sail (Figure 29) and then back down through the top cap. Double the line through the grommet (Figure 30) and secure with a couple half hitches (Figure 31). The outhaul line should be fairly snug.

8. Repeat the same procedures for the second outhaul.

9. Secure the remainder of the sail to the booms using the sail rings. Locate a grommet, place the sail ring around the boom, insert the grommet between the openings of the ring and press firmly to secure (Figures 32 and 33).

Tip: The tight of the sail rings is to ensure that the sail is securely connected to the booms. Thus pliers may be used in snapping the rings closed. However use caution when using pliers, as they can easily scratch the booms.



Figure: 26



Figure: 27

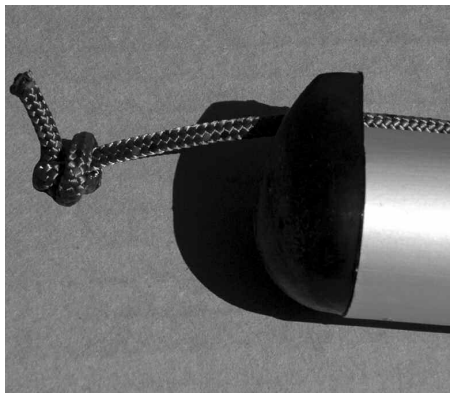

Figure: 28

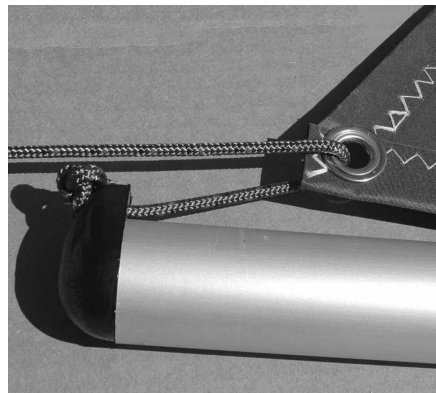

Figure: 29

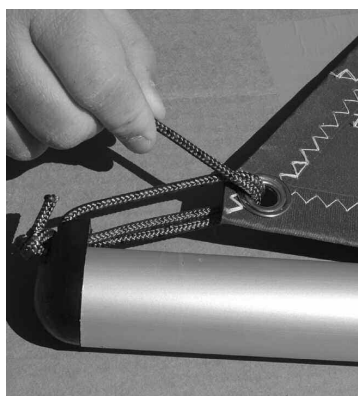

Figure: 30

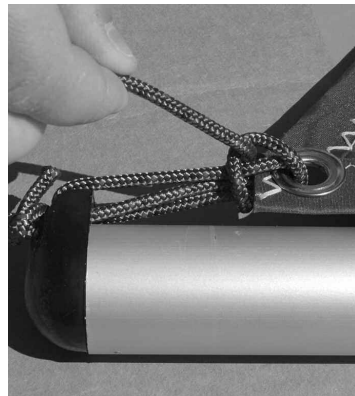
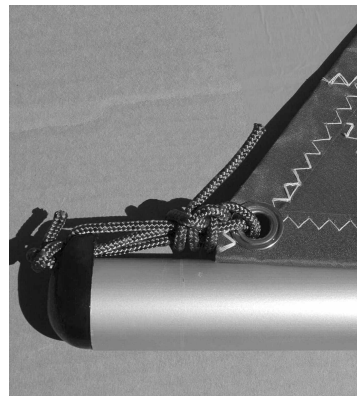

Figure: 31



Complete Outhaul

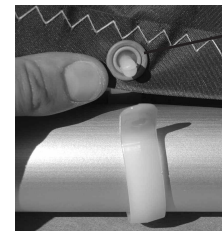

Figure: 32



Figure: 33

Attaching the Sail to the Booms (Pro):

1. From the delivery kit locate the sail, upper and lower boom, S hook, and sail ties. Remove the cunningham and outhaul line from the line bag. The white race sail is attached to the booms with sail ties as opposed to sail rings. There should be 4 sail ties that are longer than the remaining 32 ties. These longer ties are the corner sail ties.
2. Find a flat surface free of sharp objects that you can spread your sail out on.
3. Align the lower boom along the foot of the sail and the upper boom along the luff (Refer to Figure 25). The Sunfish logo should face the upper boom; the boom that does not have any blocks attached.



Figure: 34

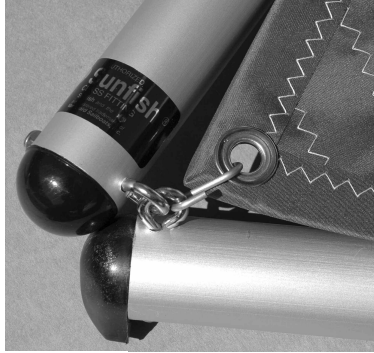

Figure: 35

4. The two booms are attached together by interlocking eye bolts. Take the S hook and loop one end through the interlocking eye bolt that is attached to the lower boom (Figure 34).

Tip: Some racers use a piece of line to secure the sail to the interlocking eye bolt as opposed to the S hook. It is suggested to use a 10" long, 2mm piece of spectra that gets led through the tack grommet and interlocking eye bolt. Wrap the line 2 or 3 times around and secure with a square knot.

5. Take the free end of the S hook and place it through the grommet in the tack of the sail. Using a pair of pliers, crimp the S hook closed (Figure 35).

6. Starting at the tack of the sail, use two of the corner ties to attach the sail to the booms (Figure 36). Start by wrapping one tie around the boom and through the grommet in the sail. The tie should be wrapped around twice before being secured with a square knot. Tie off the head and the clew of the sail with the remaining corner ties.

Tip: Make sure to set the tie at the head of the sail so that the sail's luff tension is as loose as you will want it while sailing. You will then be able to adjust the luff tension with the cunningham line.



Figure: 36



Figure: 37

7. Complete attaching the sail to the booms with the remaining sail ties. For each grommet in the sail, tie one sail tie around the boom and through the grommet. Secure with a square knot (Figure 37).

Rigging the Outhaul (Pro):

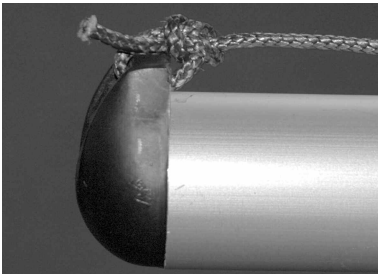

Figure: 38

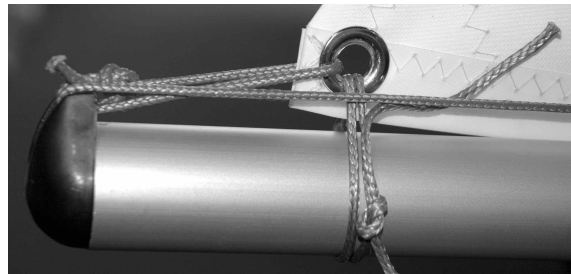

Figure: 39

1. Using the outhaul line, tie a bowline to the lower boom end cap (Figure 38).

2. Lead the free end of the line through the grommet in the sail and back through the boom end cap (Figure 39). Continue the line forward down the boom to the aft most boom cleat.

4. Tie an overhand knot in the outhaul two sail ties before the boom cleat. Lead the outhaul line through the two sail ties and through the cleat (Figure 40).

5. Lead the line back through the overhand knot and back forward through the cleat. Cleat off and tie a large bowline handle in the end (Figure 40).

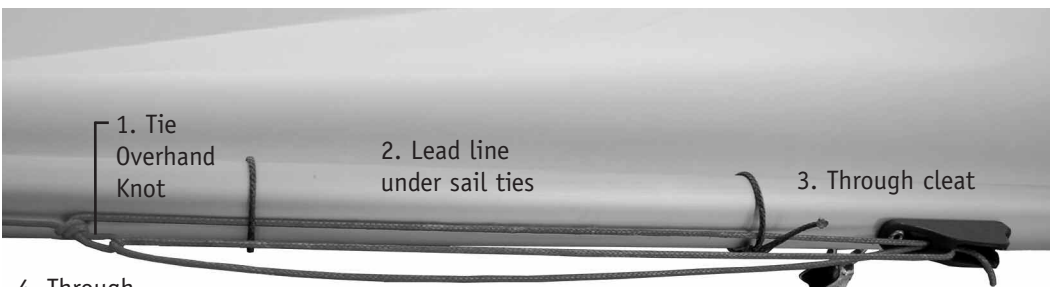

4. Through overhand knot

5. Back through cleat

6. Cleat off and tie a bowline handle

Figure: 40

Rigging the Cunningham (Pro):



Figure: 41



Figure: 42



Figure: 43

1. Using the cunningham line, tie a bowline to the interlocking eyebolt of the upper boom (Figure 41) .

2. Lead the line through the grommet in the tack of the sail (Figure 42) and continue it down through the interlocking eye bolt in the lower boom (Figure 43).

3. Feed the line through the opening in the gooseneck that retains the lower boom. Just forward of the mast tie an overhand knot (Figure 44).

4. Lead the line through the forward most cleat and back through the overhand knot. Cleat off and tie a bowline handle with the remainder of the line (Figure 45).



Figure: 44



Figure: 45

Stepping the Mast: Standard and Pro

(The directions for stepping the mast are the same for both the standard and pro models. The only differences would be sail and gooseneck bolt.)

1. Locate the mast, as well as the main halyard from the line bag. Thread one half of the halyard through the hole in the mast top cap (Figure 46).

2. **Before stepping the mast make sure that there are NO OVERHEAD WIRES in the area or leading to the launching site!**

3. Make sure that the mast step hole and mast heel are perfectly clean. Any sand, dirt, etc. in the mast step will grind into the gelcoat eventually damaging the boat.

4. Lay the booms and sail on the deck of the Sunfish. Align the gooseneck on the lower boom over the mast step hole (Figure 47).

5. Holding onto both ends of the halyard, lift the mast up setting the heel of the mast through the gooseneck ring. Slide the mast into the mast tube (Figure 48). **Be careful not to drop the mast into the tube for damage to the mast step will occur!**

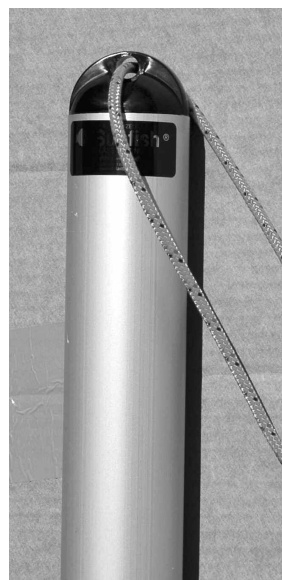

Figure: 46



Figure: 47

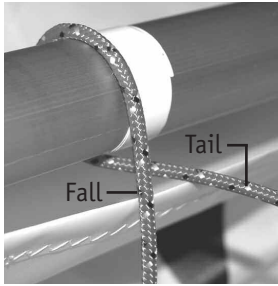

Figure: 48

Attaching the Main Halyard: Standard and Pro

The main halyard is secured to the upper boom with a clove hitch. It is suggested that you place three wraps of electrical tape around the upper booms between the ninth and tenth sail ring (counting from the tack of the sail upward). The tape helps keep the halyard from slipping up to the next sail ring or sail tie.

Note: Tying the halyard between the 9th and 10th sail ring is only a suggestion for the halyard location. You can play with the location of the halyard to raise or lower the boom depending on your comfort or wind strength. It is highly suggested not to tie the halyard up much farther; raising the boom too far off the deck may cause the mast to bend. For further information on tuning your Sunfish visit the class association at www.sunfishclass.org.



1. Find one end of the halyard (tail) and wrap it around the upper boom just below the electrical tape; leaving about a foot long tail to complete the clove hitch.

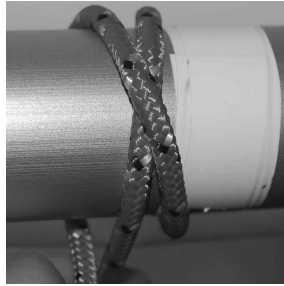

2. Lead the tail of the halyard over the fall (The fall is the remainder of the halyard) and around the upper boom again.

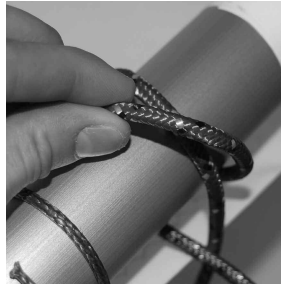

3. Where the tail crosses over the fall it forms an X. Pull up on the line that creates the top of the X.

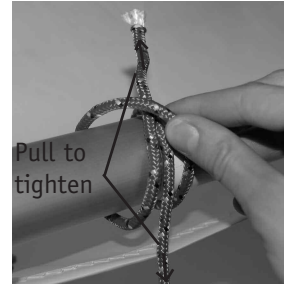

4. Lead the tail under the line you are pulling up on. Pull on the tail and fall in order to tighten around the boom.

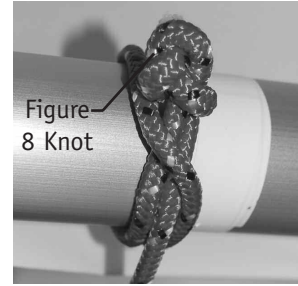

5. Tie a figure eight knot in the end of the tail.

Raising the sail: Standard and Pro

Before raising the sail make sure that the bow of the boat is pointing into the wind and you are clear of obstacles that the boom might be able to hit. Be sure to have the mainsheet and mainsheet snap shackle on hand as they will be the next parts to assemble.



1. Begin raising the sail by pulling down on the halyard.



2. You will need to assist the lower boom off the deck by raising the boom close to the gooseneck while pulling on the halyard. Continue to pull on the halyard until the upper boom is right against the top of the mast.



3. Lead the tail of the halyard through the main halyard fairlead on the deck. Tie off the halyard to the main halyard cleat.



It is suggested to coil up the remaining tail of the halyard and place it under the taught halyard section on the deck. This will keep the halyard from dragging in the water.

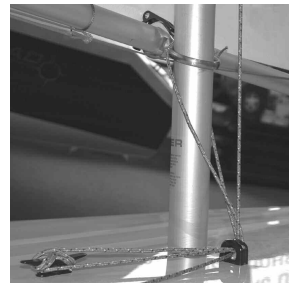

Optional: How to create a vang with the tail of your halyard

After cleating off the halyard lead the free end of the line through the fairlead, around the mast above the gooseneck, and back through the fairlead. Some racers attach the free end of the line to the daggerboard.

Attaching the Mainsheet: Standard and Pro

1. Retrieve the mainsheet from the line bag. With one end of the mainsheet tie a bowline to the mainsheet snap shackle (Figure 49).

2. Snap the mainsheet shackle onto the bridle (Figure 50).

3. Continue the free end of the mainsheet towards the bow along the boom, making sure to go through both lower boom blocks (Figure 51).

4. Lead the line down through the ratchet block. Making sure that while pulling in the mainsheet the block makes a ratcheting noise. If the block does not make a ratchet sound one of two things could be the problem. First try running the mainsheet through the block the opposite way. If this does not work, locate the lever on the mainsheet block and switch it to the ratchet position (Figure 52).

5. In the free end of the line tie a stopper knot (Figure 53).



Figure: 49

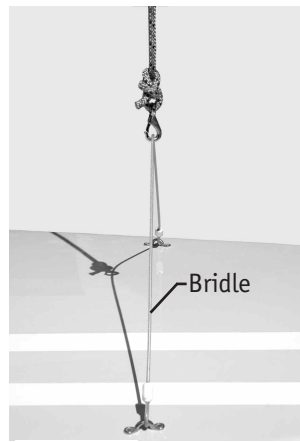

Figure: 50



Figure: 51



Figure: 52

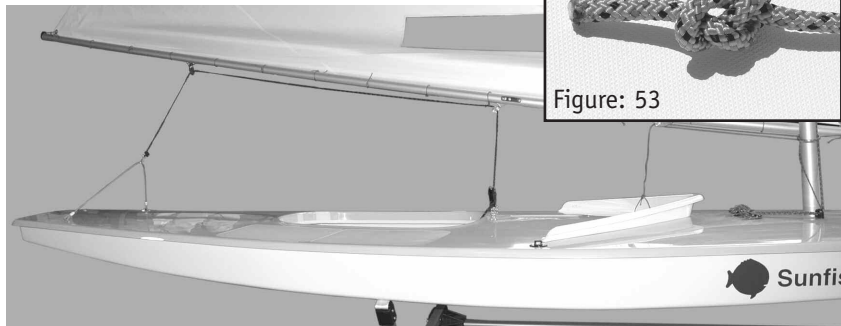

Complete Mainsheet

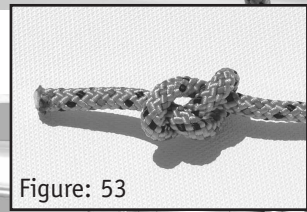
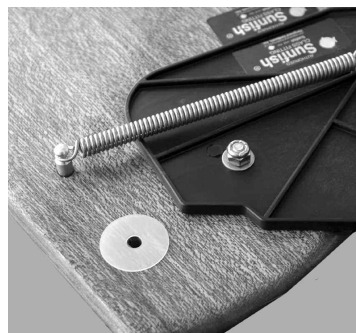

Figure: 53

Rigging the Rudder: Standard and Pro

Locate the rudder and tiller from the delivery kit. Remove the tiller bolt and the two plastic washers from the end of the black tiller straps.



1. Align the Nylon washers (one per side) with the hole in the rudder located by the rudder cheek.

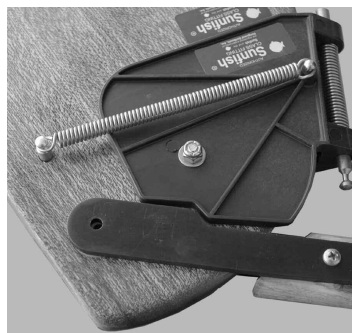

2. Align the hole in the end of the black tiller strap with that of the holes in the Nylon washers and rudder. The contour of the tiller strap should match that of the rudder cheek. It is advised to insert the washers as they are placed between the tiller strap and rudder to help prevent chafing.

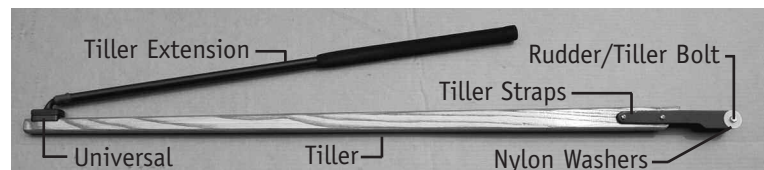

3. Insert the tiller bolt and secure with the provided locknut.



4. Using a 7/16" wrench tighten the tiller nut until the tiller fits snug to the rudder (the tiller should have some resistance yet be allowed to pivot smoothly).

Attaching the Rudder: Standard and Pro



1. Slide the tiller and extension underneath the wire bridle. The pintle pin will have two indentations that align with the two notches in the gudgeon (located on the stern of the boat). Align the pintle pin with the gudgeon notches.



2. Press down on the top of the pintle pin (compressing the pintle spring) in order to and slide the pins' indentations into the gudgeon.



3. Release the pin and the rudder should securely be attached to the boat. The rudder should be able to pivot from side to side easily. Leave the rudder in the kicked up position prior to launching.



4. The Sunfish Pro rudder attachment is the same as the standard Sunfish. The only difference between the two models is the rudder blade materials.

Daggerboard Assembly: Standard and Pro

1. Locate the Daggerboard, bungee line, retainer line, daggerboard handle line and brummel hooks (2) from the line bag and delivery kit (Figure 54).

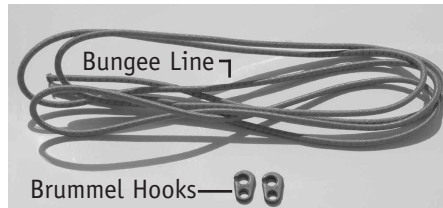

Figure: 54

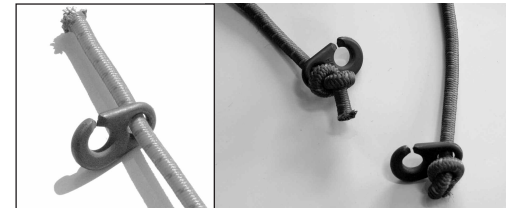

Figure: 55

2. With a stopper knot, attach the brummel hooks to each end of the bungee (Figure 55).

3. Thread the daggerboard handle line through the aft hole of the daggerboard head. There are 2 suggestions for tying the handle. Use Figures 56 - 60.



Figure: 56



Figure: 57



Figure: 58



Figure: 59



Figure: 60

4. Thread one of the brummel hooks through the hole in the daggerboard.

5. Lead the ends of the bungee around the mast (Figure 61) and through the bow handle. Connect the two brummels (Figure 62)

Find the center of the daggerboard handle line. Pass one end of the line through either hole and place the center of the line at the hole. Twist the two sides of the line around each other (Figure 56). When a sufficient handle is made by the twisting, thread one end of the line through the opposite hole (Figure 57). Secure with a square knot (Figure 58). Using a hot knife cut the ends of the knot to a desired length (Figure 59).

Thread one end of the handle line through the aft hole and tie a stopper knot. Continue the line back through the hole and tie a stopper knot on the opposite side. Pull tight. Cut excess line.

6. When you are ready to launch, slide the daggerboard into the daggerboard well. The bungee should be facing the bow while the retaining line faces the cockpit (Figure 63). Tie a bowline with the daggerboard retainer line to the aft hole of the handle in the daggerboard. With the free end of the line tie a bowline to the mainsheet block eyestay.

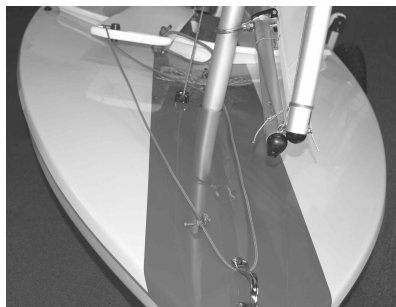

Figure: 61



Figure: 62

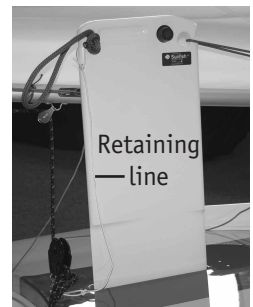

Figure: 63

Before Launching:

* Check that the drain plug on the deck is tightly in place and the automatic bailer cap is closed.

* Depending on the depth of the water, begin to slide the daggerboard into the trunk and lower the rudder (lower both down as much as the water permits. Once you are in deep enough water lower completely).

* Wear your life jacket

* Make sure that you are wearing the appropriate clothing for the conditions that you are sailing in

* Be sure to check the weather report before going sailing.

* Stay hydrated and bring plenty of water

* Wear plenty of sunscreen

De-rigging:

When you approach shallow water, begin to pull up the daggerboard as much as possible without obstructing the boom and kick up the rudder. After hopping out of the boat, detach the mainsheet shackle from the bridle line. Remove the daggerboard and place it in the cockpit. It is suggested to rinse your boat and sails with fresh water especially if you are sailing in salt water. It is also suggested to allow the sail to dry before rolling. After drying, pull the sail out taught and roll it up against the booms securing both the sails and booms to the deck with the mainsheet.

It is highly suggested to purchase covers for both the hull and blades in order to protect your boat from natural elements. A wide variety of accessories are available for purchase through your local Vanguard dealer.

Sail Care:

It is important to take proper care of your sail in order for it to last longer and perform to the standard that they were designed for. Follow these simple tips to help extend the life of your sail.

1. If you are sailing in salt water, be sure to rinse out your sail with fresh water after every use. Dacron sails do not absorb water or salt but the salt will dry on the sail making them stiff. The salt in humid weather can attract moisture that may lead to mildew on your sail.
2. To wash your sail, NEVER machine wash them. Doing so will damage the material as well as remove the finish of the sail. If your sail becomes dirty, clean it with a mild dish detergent and rinse with fresh water. Do not bleach or use other harsh chemicals on the sail for they can also ruin the finish, decreasing the life of the sail. It is not recommended to store your sail wet, doing so is an invitation for mildew to grow.
3. It is not recommended to dry your sail in the sun because other than when in use, over exposure of UV rays will slowly break down the material of the sail. Be aware of the surface that you are drying your sail on as asphalt and other parking lot surfaces are very abrasive to the sail material and may contain chemicals (i. e. oil) that can damage the sail. Avoid unnecessary flogging for it will greatly reduce the life of the sail.
4. Rolling your sail is highly recommended. Crumpling a sail will crack the finish of the material which quickly reduces the life of the sail. Purchasing a Sunfish sail and spar bag is highly recommended and are available through your local dealer.
5. Make sure to regularly inspect your sail for loose or torn stitching or small tears in the cloth. Have any stitching or tears repaired by a local sailmaker before they become more of a problem.



SEITECH dollies are the easy-to-use, light-weight, small boat transportation solution. The Sunfish dolly has been designed specifically to fit and support the shape of the hull. SEITECH dollies allow you to spend less time getting your boat to and from the water and more time on the water.

www.seitech.com

Sunfish Class Association

For more information and to link to Sunfish sailors around the world, join the Sunfish Class Association.

www.sunfishclass.org



Vanguard equips our Sunfish with the highest quality parts available from the top suppliers. We partner with key suppliers such as English Braids, North Sails and Harken to develop top of the line dinghy equipment so your boat will perform at the highest level with the factory supplied rope, sails, and hardware. Shop at an authorized Vanguard Dealer to be sure you are getting genuine Vanguard parts and accessories. Visit www.teamvanguard.com to find your local dealer.



HARKEN



STORM



Owner Information



Hull Identification Number: **OQT** _ _ _ _ _

Purchased From: _____ Date of Purchase: _____

Contact Name: _____ Phone #: _____

Address: _____

City: _____ State: _____ Zip Code: _____

Hull Color: _____ Sail #: _____

Registration Information (if applicable)

Trailer VIN #: _____

License Plate Number: _____ Licensing State: _____

Registration Number: _____ State of Registration: _____

Insurance Information: _____

Maintenance _____

